



**Rinconera**  
Baignoire d'angle  
Baignoire Hydromassante

BONITA 130



**Bañacril**  
Cabinas y Bañeras de Hidromasaje

*Le bain par* **Giani**

CHEVERE



**Bañacril**  
Cabinas y Bañeras de Hidromasaje

*Le bain par* **Giani**

NURA



**Bañacril**  
Cabinas y Bañeras de Hidromasaje

*Le bain par* **Giani**

# BAIGNOIRES D'ANGLE

BONITA 130

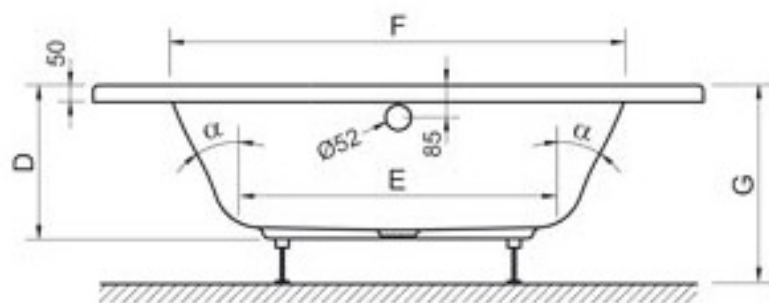
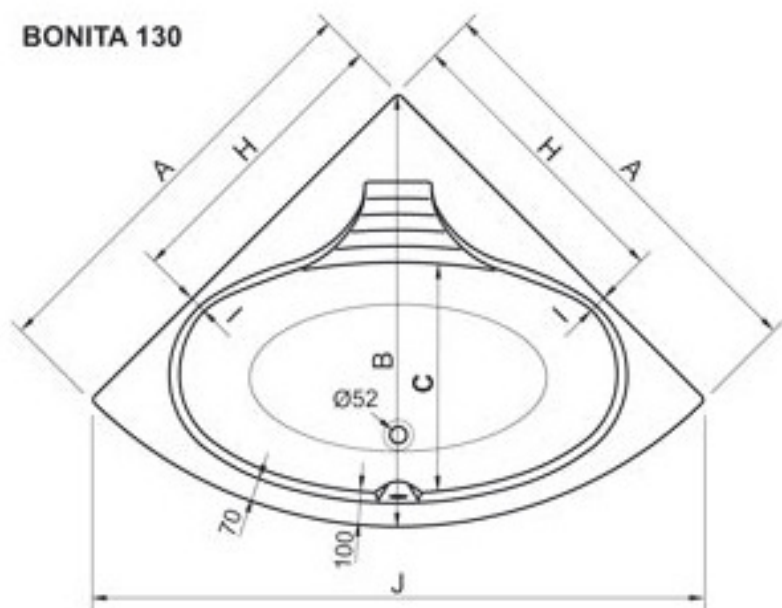

|             | A    | B    | C   | D   | E    | F    | G   | H   | I  | J    | $\alpha$ |
|-------------|------|------|-----|-----|------|------|-----|-----|----|------|----------|
| Chevere 140 | 1400 | 1480 | 770 | 475 | 1050 | 1380 | 580 | 950 | 60 | 1970 | 35°      |

CHEVERE 140

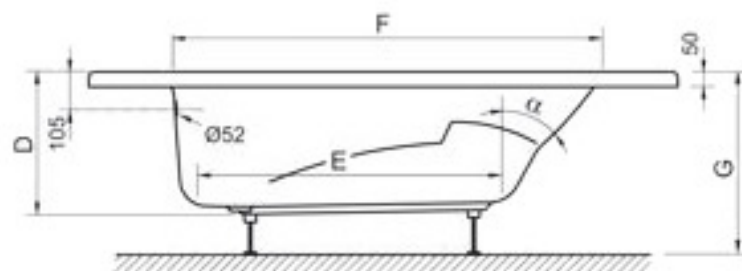
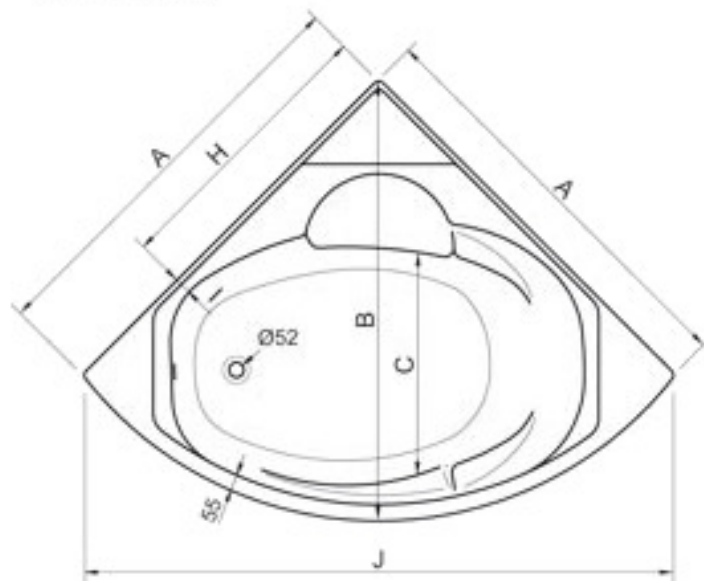

|            | A    | B    | C   | D   | E   | F    | G   | H   | I  | J    | $\alpha$ |
|------------|------|------|-----|-----|-----|------|-----|-----|----|------|----------|
| Bonita 130 | 1300 | 1300 | 700 | 455 | 960 | 1360 | 560 | 900 | 40 | 1820 | 25°      |

# BAIGNOIRES D'ANGLE

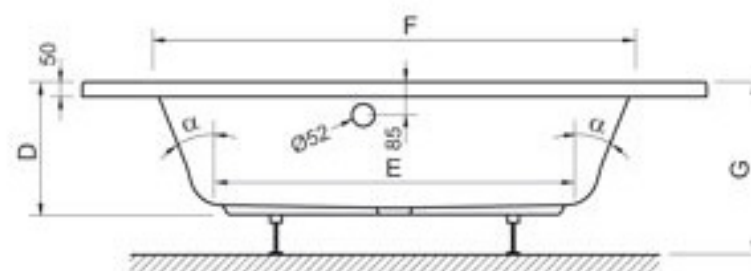
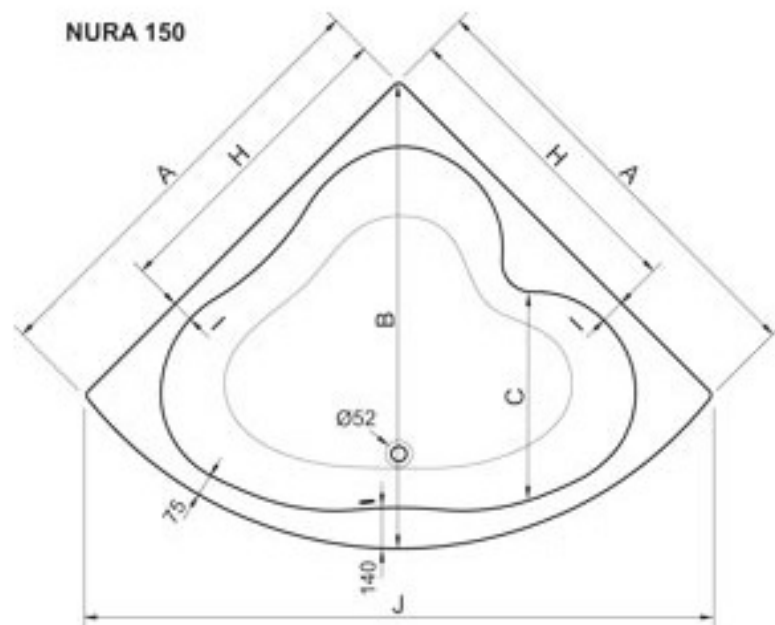

|          | A    | B    | C   | D   | E    | F    | G   | H    | I  | J    | $\alpha$ |
|----------|------|------|-----|-----|------|------|-----|------|----|------|----------|
| Nura 150 | 1500 | 1570 | 750 | 455 | 1290 | 1600 | 560 | 1050 | 70 | 2110 | 25°      |

# HYDROMASSAGE

## INTRODUCTION

Bañacril vous offre un large éventail de possibilités qui s'adaptent à tout type d'espace et à tout budget sans oublier d'offrir le maximum de confort et de prendre soin de l'élégance.

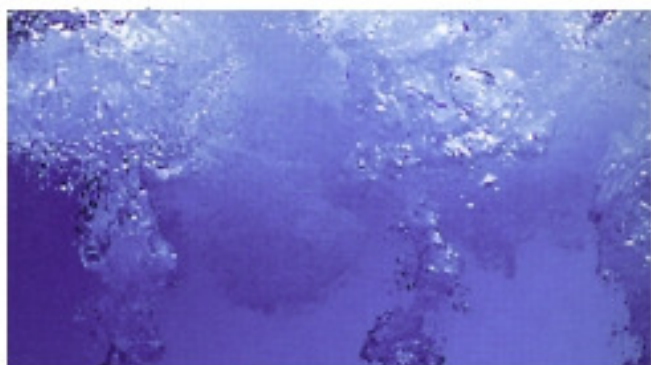

Sistema de Aire-agua/Air and Water System/ Système Air et Eau/Luft-

## Système Hydromassage Eau

Ce système effectue un massage énergétique. Il est possible d'orienter les buses vers des parties concrètes du corps. Il s'agit de jets d'eau enrichis d'air avec des sorties latérales qui peuvent être orientées et réglées. Il est spécialement recommandé pour l'arthrite, le lumbago, des récupérations postopératoires, des douleurs musculaires, le stress et la fatigue générale.









## Système Hydromassage Air

Ce système est le plus indiqué pour stimuler la circulation sanguine et pour traiter l'artériosclérose. Il comprend au moins 16 injecteurs placés au fond de la baignoire. Ces derniers injectent de l'air chaud dans la baignoire et forment des millions de bulles qui massent en douceur.











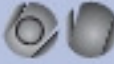





## Système Hydromassage Air et Eau

Ce système mixte est composé du système eau et du système air. Les deux systèmes peuvent fonctionner ensemble ou séparément.

| Système d'Hydromassage par modèle | AGUA ESPECIAL |           | AGUA STANDARD      |      | AIRE-AGUA |                    | AIRE DIGITAL |           | AGUA DIGITAL       |            | AIRE-AGUA |           | HIDROTHERMAL |                    |                      |        |           |
|-----------------------------------|---------------|-----------|--------------------|------|-----------|--------------------|--------------|-----------|--------------------|------------|-----------|-----------|--------------|--------------------|----------------------|--------|-----------|
|                                   | JETS          | JETS AGUA | MICROJETS OPCIONAL | JETS | JETS      | MICROJETS OPCIONAL | JETS AIRE    | JETS AGUA | MICROJETS DE SERIE | KIT LUXE 1 | JETS AIRE | JETS AGUA |              | MICROJETS DE SERIE | KIT LUXE 1KIT LUXE 2 | VENTIL | JETS AIRE |
| BONITA 130                        |               | 6         | 2                  | 16   | 6         | 2                  | 16           | 6         | 2                  | 1          | 16        | 6         | 2            | 1                  | 1                    |        |           |
| NURA                              |               | 6         | 2                  | 16   | 6         | 2                  | 16           | 6         | 2                  | 1(b)       | 16        | 6         | 2            | 1(b)               |                      |        |           |
| CHEVERE                           |               | 6         | 2                  | 16   | 6         | 2                  | 16           | 6         | 2                  | 1(b)       | 16        | 6         | 2            | 1(b)               |                      |        |           |

| Funciones<br>Functions<br>Fonctions<br>Funktionen                                  |  | Sistemas de Agua<br>Water Systems<br>Hydromassage d'eau<br>Wasser Systeme |  |   | Sistemas Aire<br>Air Systems<br>Hydromassage d'air<br>Luft Systeme    |   | Sistemas de Aire y Agua<br>Air and Water System<br>Hydromassage d'air-eau<br>Luft-Wasser Systeme   |  |
|--|--|---|--|---|---|---|--|--|
|  |  | Agua Especial<br>Special Water<br>Eau Spécial<br>Jet TL<br>Wassersystem   | Agua Standard<br>Standard Water<br>Eau Standard<br>Pneumatisches<br>Wassersystem | Agua Digital<br>Digital Water<br>Eau Digital<br>Digitales<br>Wassersystem | Aire Digital<br>Digital Air<br>Air Digital<br>Digitales<br>Luftsystem | Hidrotermal<br>Hydrothermal<br>Hydrothermal | Aire-Agua Standard<br>Air-Water Standard<br>Air-Eau Standard<br>Pneumatisches<br>Luft-Wassersystem | Aire-Agua Digital<br>Digital Air-Water<br>Air-Eau Digital<br>Digitales Luft-<br>Wassersystem |
|    | Baño de Agua/Water Bath/Bain Eau/<br>Wassermassage   | ●   | ●  | ●   |   |   | ●  | ●  |
|    | Baño de Aire/Air Bath/Bain Air/Luftmassage   |   |  |   | ●   | ●   | ●  | ●  |
|    | Baño Ola de Agua/Water Wave Bath/Bain<br>Vague Eau/Wellen-Wassermassage  |   |  | ●   |   |   |  | ●  |
|    | Baño Ola de Aire/Air Wave Bath/Bain Vague<br>Air/Wellen-Luftmassage  |   |  |   | ●   |   |  | ●  |
|    | Programa tonificante/Toning Programme/<br>Programmation tonifiante/Erfrischungs Programm   |   |  |   |   | ●   |  |  |
|    | Programa relajante/Relaxation Programme/<br>Programmation délassante/Relax Programm  |   |  |   |   | ●   |  |  |
|   | Regulación intensidad motobomba/<br>Regulation intensity pump/Réglage d' intensité<br>motopompe/Intensitätsregulierung Motorpumpe  |   |  | ●   |   |   |  | ●  |
|  | Regulación intensidad motosoplante/<br>Regulation intensity blower/Réglage d' intensité<br>Turbine/Intensitätsregulierung Luftgebläse                                    |   |  |   | ●   | ●   |  | ●  |
|  | Regulación presión masaje con venturi/<br>Regulation massagepressure with venturi/<br>Réglage pression massage avec venturi/<br>Regulierung Massagedruck mittels Venturi | ●   | ●  |   |   |   | ●  |  |



| Funciones<br>Functions<br>Fonctions<br>Funktionen   | Sistemas de Agua<br>Water Systems<br>Hydromassage d'eau<br>Wasser Systeme         |   |   | Sistemas Aire<br>Air Systems<br>Hydromassage d'air<br>Luft Systeme                  |   | Sistemas de Aire y Agua<br>Air and Water System<br>Hydromassage d'air-eau<br>Luft-Wasser Systeme   |  |
|---|---|---|---|---|---|--|--|
|   | Agua Especial<br>Special Water<br>Eau Spécial<br>Jet TL<br>Wassersystem           | Agua Standard<br>Standard Water<br>Eau Standard<br>Pneumatisches<br>Wassersystem    | Agua Digital<br>Digital Water<br>Eau Digital<br>Digitales<br>Watersystem            | Aire Digital<br>Digital Air<br>Air Digital<br>Digitales<br>Luftsystem               | Hidrotermal<br>Hydrothermal<br>Hydrothermal | Aire-Agua Standard<br>Air-Water Standard<br>Air-Eau Standard<br>Pneumatisches<br>Luft-Wassersystem | Aire-Agua Digital<br>Digital Air-Water<br>Air-Eau Digital<br>Digitales Luft-<br>Wassersystem |
|  <b>Pulsador-Mando distancia</b> /Standard Control-Remote Control/Commande pneumatique Standard-Télécommande/Pneumatische Ein-Aus-Taste-Fernbedienung |  |  |  |  |   |                 |           |
|  <b>Control nivel de Agua</b> /Water level/Niveau d'eau/Trockenlaufschutz   | Neum  | Neum  | Dig   | Dig   | Dig   | Dig  | Dig  |
|  <b>Vaciador automático</b> /Automatic drainage/Vidange automatique/Excentrische Ab-und Überlaufgarnitur  | Opc.  | ●   | ●   | ●   | ●   | ●  | ●  |
|  <b>Temporizador seguridad</b> /Security timer/Temporisateur de sécurité/Sicherheits Zeitschalter   |   | ●   | ●   | ●   | ●   | ●  | ●  |
|  <b>Jets de Agua</b> /Waterjets/Buses d'eau/Wasserdüse  | 6   | 6-8   | 6-8   |   |   | 6-8  | 6-8  |
|  <b>Jets de Aire</b> /Airjets/Buses d'air/Luftdüsen   |   |   |   | 16-20   | 42  | 16-20  | 16-20  |
|  <b>Motobomba</b> /Pump/Motopompe/Motorpumpe  | 0,7 kW  | 0,9 kW  | 0,9-1,5 kW <sup>(*)</sup>   |   |   | 0,9 kW   | 0,9-1,5 kW <sup>(*)</sup>  |
|  <b>Motor soplante con calefactor</b> /Blower with heater/Turbine avec radiateur d'air compris/Luftgebläse mit Luftheizung                          |   |   |   | 1,1 kW  | 0,8 kW                                      | 1,1 kW   | 1,1 kW   |
| <b>Kit de Luxe 1</b>   |   |   |   |   |   |  |  |
| <b>Kit de Luxe 2 (*)</b>   |   |   | Opc.  |   |   |  | Opc.   |
|  <b>Reposacabezas adhesivos</b> /Adhesive Headrest/Repose-tête autocollant/Abnehmbare Kopfstütze  | Opc.  | Opc.  | ●   | ●   | ●   | Opc.   | ●  |

(\*) según modelo /depending on model /suivant les modèles /abhängig von Modell

[www.gianicarrelage.fr](http://www.gianicarrelage.fr)

*mon carrelage, mon plus beau meuble !*

**Bañacril**  
Cabinas y Bañeras de Hidromasaje



**Giani**  
**CARRELAGE**

ROUTE DE LOURDES  
65290 JUILLAN  
TEL. 05 62 45 49 05  
FAX 05 62 32 54 91

*Le bain par Giani*